

**DS-2CD2346G2-ISU/SL**

**4 MP AcuSense Strobe Light and Audible Warning Fixed Turret Network Camera**

AcuSense

114-157x



Empowered by deep learning algorithms, Hikvision AcuSense technology brings human and vehicle targets classification alarms to front- and back-end devices. The system focuses on human and vehicle targets, vastly improving alarm efficiency and effectiveness.

- High quality imaging with 4 MP resolution
- Excellent low-light performance with powered-by-DarkFighter technology
- Clear imaging against strong backlight due to 120 dB true WDR technology
- Efficient H.265+ compression technology
- Focus on human and vehicle targets classification based on deep learning
- Active strobe light and audio alarm to warn intruders off
- Provides real-time security via built-in two-way audio
- Water and dust resistant (IP67)

## ▪ Specification

Camera	
Image Sensor	1/3" Progressive Scan CMOS
Min. Illumination	Color: 0.003 Lux @ (F1.4, AGC ON), B/W: 0 Lux with IR
Shutter Speed	1/3 s to 1/100,000 s
Slow Shutter	Yes
P/N	P/N
Wide Dynamic Range	120 dB
Day & Night	IR cut filter
Angle Adjustment	Pan: 0° to 360°, tilt: 0° to 75°, rotate: 0° to 360°
Lens	
Lens Type	Fixed focal lens, 2.8, 4, and 6 mm optional
Iris Type	Fixed
Focal Length & FOV	2.8 mm, horizontal FOV 103°, vertical FOV 55°, diagonal FOV 123° 4 mm, horizontal FOV 83°, vertical FOV 45°, diagonal FOV 98° 6 mm, horizontal FOV 53°, vertical FOV 29°, diagonal FOV 62°
Aperture	F1.4
Lens Mount	M12
DORI	
DORI	2.8 mm: D: 60.0 m, O: 23.8 m, R: 12.0 m, I: 6.0 m 4 mm: D: 80.0 m, O: 31.7 m, R: 16.0 m, I: 8.0 m 6 mm: D: 120.0 m, O: 47.6 m, R: 24.0 m, I: 12.0 m
Illuminator	
Supplement Light Type	IR
IR Range	Up to 30 m
IR Wavelength	Yes
Smart Supplement Light	Yes
Visual Alarm	Yes
Video	
Max. Resolution	2688 × 1520
Main Stream	50 Hz: 25 fps (2688 × 1520, 1920 × 1080, 1280 × 720) 60 Hz: 30 fps (2688 × 1520, 1920 × 1080, 1280 × 720)
Sub-Stream	50 Hz: 25 fps (640 × 480, 640 × 360) 60 Hz: 30 fps (640 × 480, 640 × 360)
Third Stream	50 Hz: 10 fps (1920 × 1080, 1280 × 720, 640 × 480, 640 × 360) 60 Hz: 10 fps (1920 × 1080, 1280 × 720, 640 × 480, 640 × 360) *Third stream is supported under certain settings.
Video Compression	Main stream: H.265/H.264/H.265+/H.264+ Sub-stream: H.265/H.264/MJPEG Third stream: H.265/H.264 *Third stream is supported under certain settings.
Video Bit Rate	32 Kbps to 8 Mbps
H.264 Type	Baseline Profile/Main Profile/High Profile
H.265 Type	Main Profile
H.264+	Main Stream supports

H.265+	Main stream supports
Bit Rate Control	CBR/VBR
Scalable Video Coding (SVC)	H.264 and H.265 encoding
Region of Interest (ROI)	1 fixed region for main stream and sub-stream
<b>Audio</b>	
Environment Noise Filtering	Yes
Audio Sampling Rate	8 kHz/16 kHz/32 kHz/44.1 kHz/48 kHz
Audio Compression	G.711ulaw/G.711alaw/G.722.1/G.726/MP2L2/PCM/MP3/AAC
Audio Bit Rate	64 Kbps (G.711ulaw/G.711alaw)/16 Kbps (G.722.1)/16 Kbps (G.726)/32 to 192 Kbps (MP2L2)/8 to 320 Kbps (MP3)/16 to 64 Kbps (AAC)
<b>Network</b>	
Simultaneous Live View	Up to 6 channels
API	Open Network Video Interface (PROFILE S, PROFILE G, PROFILE T), ISAPI, SDK
Protocols	TCP/IP, ICMP, HTTP, HTTPS, FTP, DHCP, DNS, DDNS, RTP, RTSP, NTP, UPnP, SMTP, IGMP, 802.1X, QoS, IPv4, IPv6, UDP, Bonjour, SSL/TLS, PPPoE, SNMP, ARP
User/Host	Up to 32 users. 3 user levels: administrator, operator and user
Security	Password protection, complicated password, HTTPS encryption, IP address filter, Security Audit Log, basic and digest authentication for HTTP/HTTPS, TLS 1.1/1.2, WSSE and digest authentication for Open Network Video Interface
Network Storage	MicroSD/SDHC/SDXC card (256 GB) local storage, and NAS (NFS, SMB/CIFS), auto network replenishment (ANR) Together with high-end Hikvision memory card, memory card encryption and health detection are supported
Client	iVMS-4200, Hik-Connect, Hik-Central
Web Browser	Plug-in required live view: IE 10+ Plug-in free live view: Chrome 57.0+, Firefox 52.0+ Local service: Chrome 57.0+, Firefox 52.0+
<b>Image</b>	
SNR	≥ 52 dB
Day/Night Switch	Day, Night, Auto, Schedule
Image Enhancement	BLC, HLC, 3D DNR
Image Parameters Switch	Yes
Image Settings	Rotate mode, saturation, brightness, contrast, sharpness, gain, white balance adjustable by client software or web browser
<b>Interface</b>	
Alarm	1 input, 1 output (max. 24 VDC/24 VAC, 500 mA)
Audio	1 input (line in), terminal block, max. input amplitude: 3.3 Vpp, input impedance: 4.7 KΩ, interface type: non-equilibrium; 1 output (line out), terminal block, max. output amplitude: 3.3 Vpp, output impedance: 100 Ω, interface type: non-equilibrium
Built-in Microphone	Yes
Built-in Speaker	Power: 1.2 W. Max. sound pressure level: 10 cm: 95 dB.
On-Board Storage	Built-in micro SD/SDHC/SDXC slot, up to 256 GB
Hardware Reset	Yes
Ethernet Interface	1 RJ45 10 M/100 M self-adaptive Ethernet port

Event	
Basic Event	Motion detection (human and vehicle targets classification), video tampering alarm, exception
Smart Event	Scene change detection
Deep Learning Function	
Face Capture	Yes
Perimeter Protection	Line crossing detection, intrusion detection, region entrance detection, region exiting detection
General	
Linkage Method	Upload to NAS/memory card/FTP, notify surveillance center, trigger recording, trigger capture, strobe light, audible warning, send email
Web Client Language	33 languages English, Russian, Estonian, Bulgarian, Hungarian, Greek, German, Italian, Czech, Slovak, French, Polish, Dutch, Portuguese, Spanish, Romanian, Danish, Swedish, Norwegian, Finnish, Croatian, Slovenian, Serbian, Turkish, Korean, Traditional Chinese, Thai, Vietnamese, Japanese, Latvian, Lithuanian, Portuguese (Brazil), Ukrainian
General Function	Anti-flicker, heartbeat, mirror, privacy mask, flash log, password reset via email, pixel counter
Software Reset	Yes
Firmware Version	V5.5.112
Storage Conditions	-30 °C to 60 °C (-22 °F to 140 °F). Humidity 95% or less (non-condensing)
Startup and Operating Conditions	-30 °C to 60 °C (-22 °F to 140 °F). Humidity 95% or less (non-condensing)
Power Supply	12 VDC ± 25%, reverse polarity protection PoE: 802.3af, Class 3
Power Consumption and Current	12 VDC, 0.65 A, max. 7.8 W PoE (802.3af, 36 V to 57 V), 0.25 A to 0.15 A, max. 8.8 W
Power Interface	Ø5.5 mm coaxial power plug
Camera Material	Metal except for trim ring
Camera Dimension	Ø138.3 mm × 124.5 mm (Ø5.4" × 4.9")
Package Dimension	170 mm × 170 mm × 150 mm (6.9" × 6.9" × 5.9")
Camera Weight	Approx. 825 g (1.8 lb.)
With Package Weight	Approx. 1120 g (2.5 lb.)
Approval	
EMC	FCC (47 CFR Part 15, Subpart B); CE-EMC (EN 55032: 2015, EN 61000-3-2: 2014, EN 61000-3-3: 2013, EN 50130-4: 2011 +A1: 2014); RCM (AS/NZS CISPR 32: 2015); IC (ICES-003: Issue 6, 2016); KC (KN 32: 2015, KN 35: 2015)
Safety	UL (UL 60950-1); CB (IEC 60950-1: 2005 + Am 1: 2009 + Am 2: 2013, IEC 62368-1: 2014 ); CE-LVD (EN 60950-1: 2005 + Am 1: 2009 + Am 2: 2013, IEC 62368-1: 2014 ); BIS (IS 13252(Part 1): 2010+A1: 2013+A2: 2015); LOA (IEC/EN 60950-1)
Environment	CE-RoHS (2011/65/EU); WEEE (2012/19/EU); Reach (Regulation (EC) No 1907/2006)
Protection	IP67 (IEC 60529-2013)



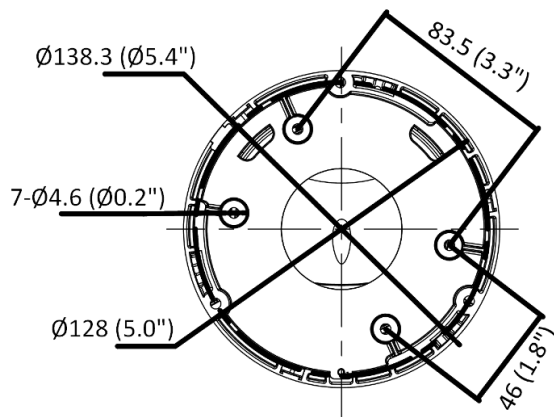
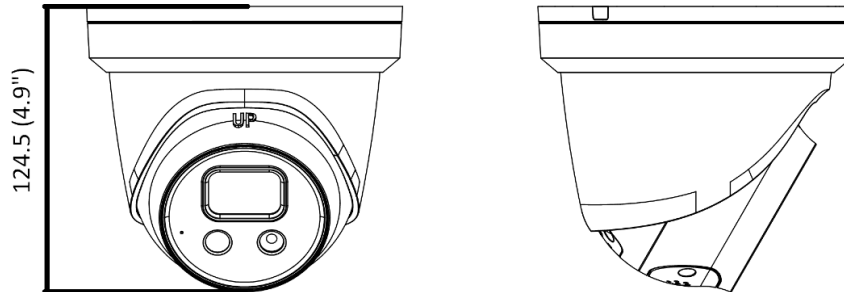



▪ **Dimension**



Unit: mm (inch)

▪ **Accessory**

▪ **Optional**

DS-1275ZJ-SUS Vertical Pole Mount	DS-1273ZJ-140B Wall Mount	DS-1273ZJ-140 Wall Mount	DS-1273ZJ-140(BLACK) Wall Mount	DS-1271ZJ-140 Pendant Mount
				
DS-1276ZJ-SUS Corner Mount	DS-1280ZJ-PT6 Junction Box			
				

## ORDERING INFORMATION

---

114-157 Hikvision DS-2CD2346G2-ISU/SL 4 MP Fixed Turret Network Camera 2.8mm

114-157B Hikvision DS-2CD2346G2-ISU/SL 4 MP Fixed Turret Network Camera 2.8mm  
inc Built-in microphone and speaker, Audio/Alarm I/O



Innovative Electronic Solutions  
[www.ness.com.au](http://www.ness.com.au)



**NSW** Ph 02 8825 9222  
[sales@ness.com.au](mailto:sales@ness.com.au)

**VIC** Ph 03 9875 6400  
[nessmelb@ness.com.au](mailto:nessmelb@ness.com.au)

**QLD** Ph 07 3399 4910  
[nessbris@ness.com.au](mailto:nessbris@ness.com.au)

**WA** Ph 08 9328 2511  
[nessper@ness.com.au](mailto:nessper@ness.com.au)

**SA** Ph 08 8152 0000  
[adelaide@ness.com.au](mailto:adelaide@ness.com.au)